



# Modular Cooking Range Line 700XP Two Wells Gas Fryer Top 7 liter

ITEM # \_\_\_\_\_

MODEL # \_\_\_\_\_

NAME # \_\_\_\_\_

SIS # \_\_\_\_\_

AIA # \_\_\_\_\_

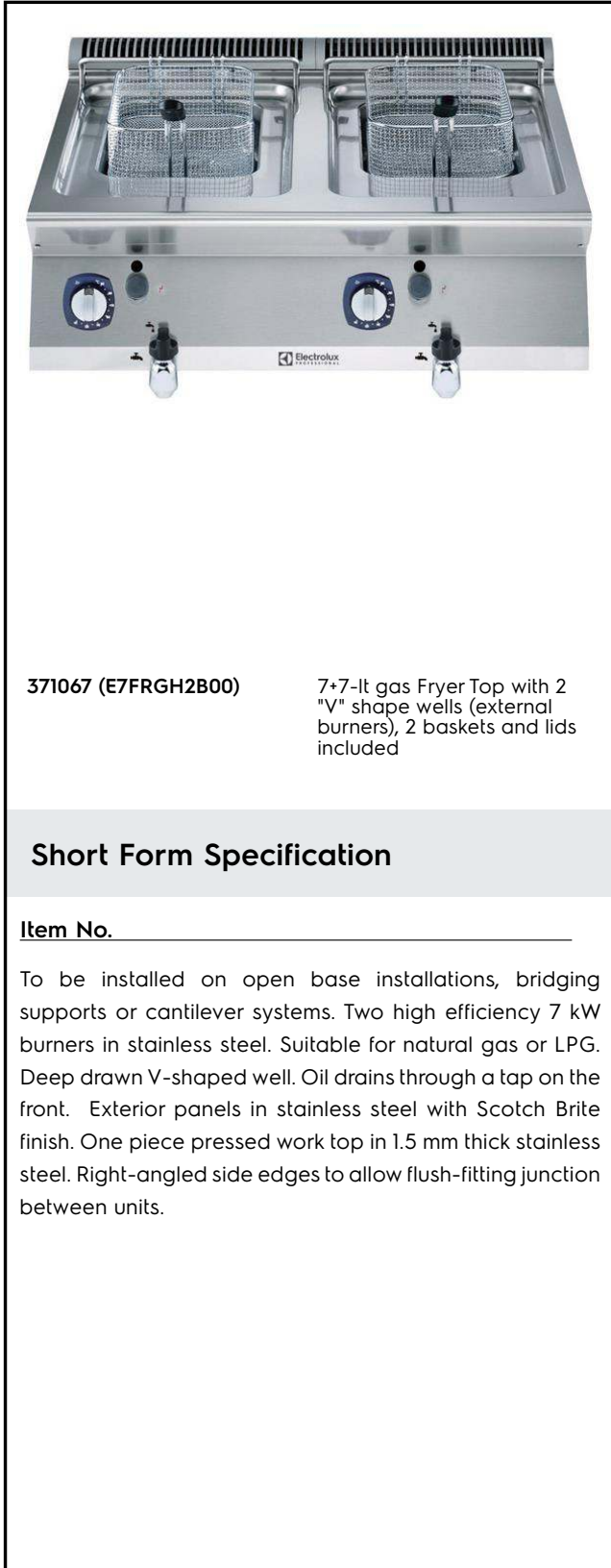

371067 (E7FRGH2B00)

7+7-lt gas Fryer Top with 2 "V" shape wells (external burners), 2 baskets and lids included

## Short Form Specification

Item No. \_\_\_\_\_

To be installed on open base installations, bridging supports or cantilever systems. Two high efficiency 7 kW burners in stainless steel. Suitable for natural gas or LPG. Deep drawn V-shaped well. Oil drains through a tap on the front. Exterior panels in stainless steel with Scotch Brite finish. One piece pressed work top in 1.5 mm thick stainless steel. Right-angled side edges to allow flush-fitting junction between units.

## Main Features

- Unit to be mounted on open base cupboards, bridging supports or cantilever systems.
- Deep drawn V-Shaped wells.
- Interior of wells with rounded corners for ease of cleaning.
- Two high efficiency 7 kW burners in stainless steel with flame failure device attached to the outside of the wells.
- Thermostatic regulation of oil temperature up to a maximum of 185 °C.
- Flame failure device on each burner.
- Overheat protection thermostat as standard on all units.
- Oil drains through a tap positioned on the front the wells.
- All major compartments located in front of unit for ease of maintenance.
- Piezo spark ignition for added safety.
- Gas appliance supplied for use with natural or LPG gas, conversion jets supplied as standard.
- IPx4 water protection.
- Optional portable oil quality monitoring tool (code 9B8081) for efficient oil management.
- Suitable for countertop installation.

## Construction

- All exterior panels in Stainless Steel with Scotch Brite finishing.
- One piece pressed 1.5 mm work top in Stainless steel.
- Model has right-angled side edges to allow flush fitting joints between units, eliminating gaps and possible dirt traps.

## Sustainability



- This model is compliant with Swiss Energy Efficiency Ordinance (730.02).

## Included Accessories

- 2 of Basket for 7lt top and free standing fryers PNC 921608

## Optional Accessories

- Junction sealing kit PNC 206086
- Draught diverter, 150 mm diameter PNC 206132
- Matching ring for flue condenser, 150 mm diameter PNC 206133
- Support for bridge type installation, 800mm PNC 206137
- Support for bridge type installation, 1000mm PNC 206138
- Support for bridge type installation, 1200mm PNC 206139
- Support for bridge type installation, 1400mm PNC 206140
- Support for bridge type installation, 1600mm PNC 206141

APPROVAL: \_\_\_\_\_



Experience the Excellence  
www.electroluxprofessional.com



**Electrolux**  
PROFESSIONAL

## Modular Cooking Range Line 700XP Two Wells Gas Fryer Top 7 liter

- Flue condenser for 1 module, 150 mm diameter PNC 206246
- Chimney upstand, 800mm PNC 206304
- Right and left side handrails PNC 206307
- Back handrail 800 mm PNC 206308
- Chimney grid net, 400mm (700XP/900) PNC 206400
- Kit G.25.3 (Ni) gas nozzles for 900 fryers PNC 206467
- 2 side covering panels for top appliances PNC 216277
- Basket for 7lt top and free standing fryers PNC 921608
- Pressure regulator for gas units PNC 927225



Modular Cooking Range Line  
700XP Two Wells Gas Fryer Top 7 liter

The company reserves the right to make modifications to the products without prior notice. All information correct at time of printing.

2025.01.17

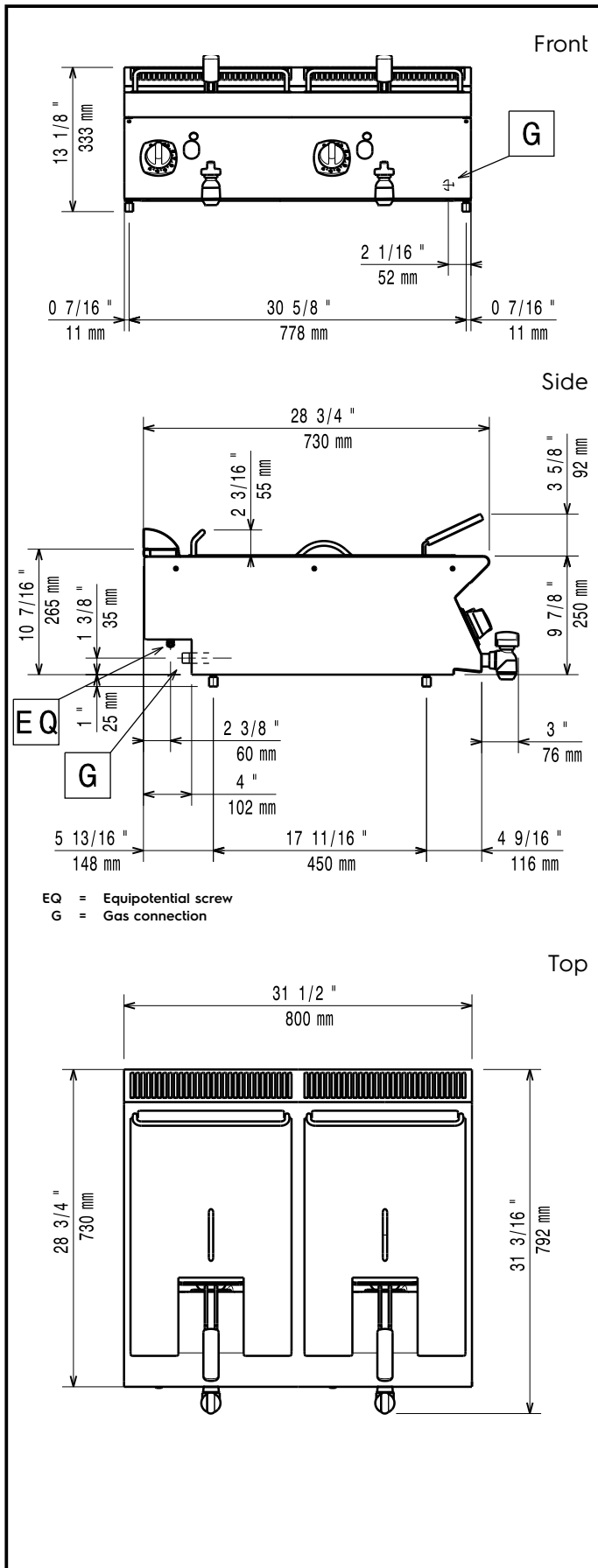

### Gas

<b>Gas Power:</b>	371067 (E7FRGH2B00)	14 kW
<b>Standard gas delivery:</b>		Natural Gas G20 (20mbar)
<b>Gas Type Option:</b>		LPG; Natural Gas
<b>Working pressure, mBar (min/Max):</b>		0 / 0
<b>Gas Inlet:</b>		1/2"

### Key Information:

<b>Usable well dimensions (width):</b>	240 mm
<b>Usable well dimensions (height):</b>	235 mm
<b>Usable well dimensions (depth):</b>	380 mm
<b>Well capacity:</b>	5.5 lt MIN; 7 lt MAX
<b>Thermostat Range:</b>	105 °C MIN; 185 °C MAX
<b>Net weight:</b>	47 kg
<b>Shipping weight:</b>	54 kg
<b>Shipping height:</b>	540 mm
<b>Shipping width:</b>	820 mm
<b>Shipping depth:</b>	860 mm
<b>Shipping volume:</b>	0.38 m <sup>3</sup>

If appliance is set up or next to or against temperature sensitive furniture or similar, a safety gap of approximately 150 mm should be maintained or some form of heat insulation fitted.

**Certification group:** N7FG